

Long distance adaptor



Features

- When PanTilt door is more than 100m to max. 300m away.
- Separate power supply allows mounting MYW-BA up to 50m away from master station or adaptor.

Used for

MK-1GD, MK-2MCD
MY-CU w/IE-8MD or TD-H/B
MYW-P1L or MYW-P3L w/LEF
LEF-C
TB-ADM10 w/TC-M

Unit dimensions

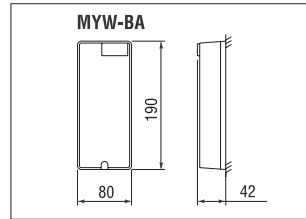

Wiring

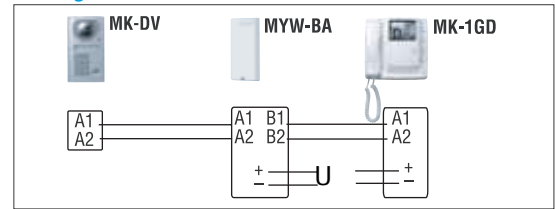

Cable

Impedance: 90Ω. Permitted closed loop DC resistance: 9.9Ω or less. PE insulation (not PVC).

Specifications

Power source	PS-1820DIN of system or separate
Current consumption	250mA. 1mA standby.
Wiring	2 parallel wires to ea. door & master.
Distance	MYW-BA~door 200m(1.0mmø) 300m(1.2mmø) MYW-BA~master 50m(1.0 or 1.2mmø) MYW-BA~PS 7m(1.0mmø) 10m(1.2mmø)

Selective door release adaptor

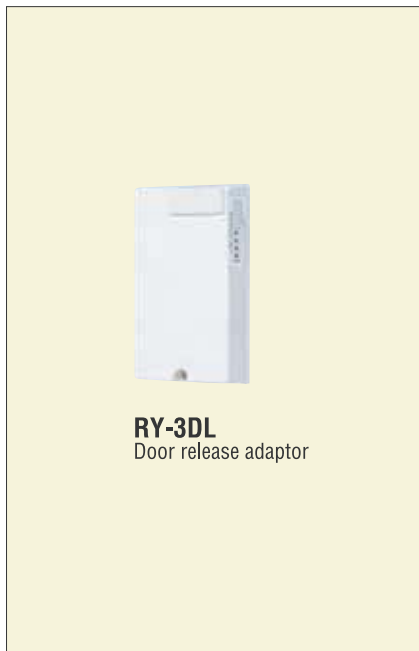

Features

- Selective door release with one button
- Door release contacts release the door where communication is established.
- Normally open contacts for electric strike. Normally closed contacts to work with magnetic locks.

Used for

MK-2MCD, KB-3MRD
JB-2MED, JB-2MD, IE-2AD(U)

Unit dimensions

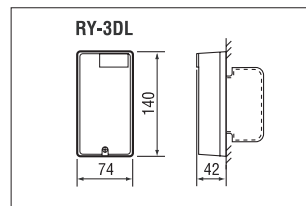

Wiring

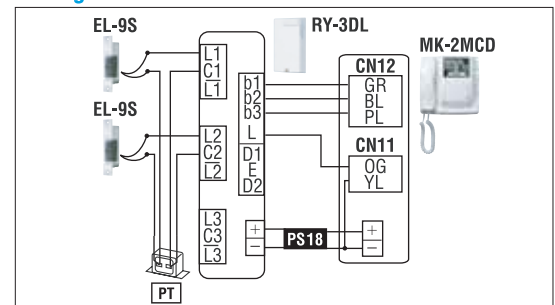

GR : Green. BL : Blue. PL : Purple. OG : Orange. YL : Yellow.
[PT] : AC transformer [PS18] : PS-1820DIN

Specifications

Power source	12~24V DC, 30mA. 12~16V AC, 60mA.
Power supply	PS-2420DIN, PS-1820DIN, PS-1215DIN, AC trans.
Relay contacts	Normally open output. 1A at 50V AC. 1A at 30V DC (for other types, use matching relay)
Wiring distance	Master to RY-3DL 50m(0.65mmø) 100m(1.0mmø) RY-3DL to EL-9S 50m(0.65mmø) 100m(1.0mmø)

Call extension

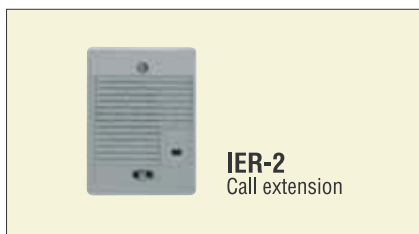

Features

- Announces (chime) call tone only, adjustable
- Indoor mounting

Used for

IE series, MK-1GD, MK-2MCD, KC-1MRD
KC-1GRD, KB-3MRD, NEM-n, NEM-nA, TC-M
JB-2MD, JB-2MED, JA-2MECD, JA-2MCD

Unit dimensions

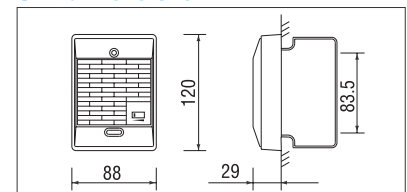

Door release



Features

- Door release activation, momentary or talk line-controlled

Specifications

Power source	12V AC, 0.35A, powered by AC trans.
--------------	-------------------------------------