

Long distance adaptor

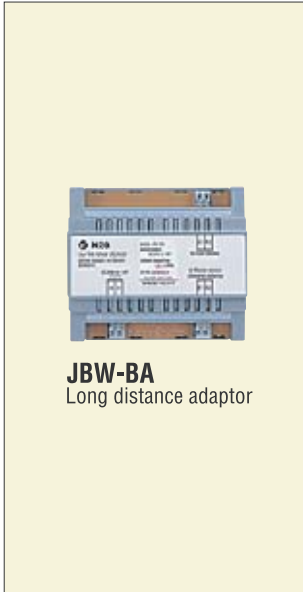

Features

- When color video door station is more than 100m to max. 350m away.
- One required for each door station.

Used for

KC-1MRD, KC-1GRD
KC-32EU + KC-1ARD/KC-1GRD
JA-2MECD, JA-2MCD
JB-2MD, JB-2MED

Unit dimensions

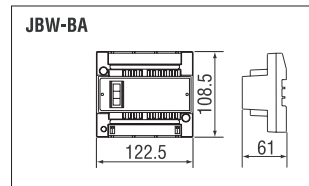

Wiring

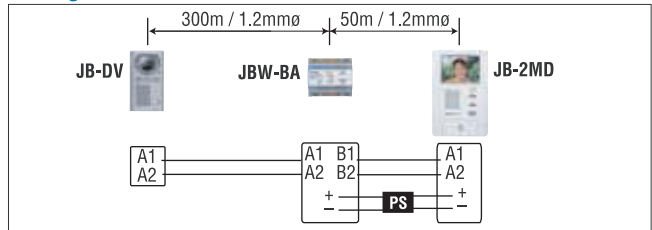

Cable

1.0mmø to 1.2mmø. Solid copper conductor PE insulation (not PVC).

Specifications

Power source	18VDC, 24VDC PS-1820DIN or PS-2420S, etc. of system or separate
Current consumption	120mA.
Wiring	2 parallel wires to ea. door & master.
Distance	JBW-BA-door 100m~200m(1.0mmø) 100m~300m(1.2mmø) JBW-BA-master 50m(1.0 or 1.2mmø) JBW-BA-PS 50m(1.0 or 1.2mmø)

Selective door release adaptor



Features

- Selective door release with one button
- Door release contacts release the door where communication is established.
- Normally open contacts for electric strike. Normally closed contacts to work with magnetic locks.

Used for

KB-3MRD, JB-2MED, JB-2MD
MK-2MCD, IE-2AD(U)

Unit dimensions

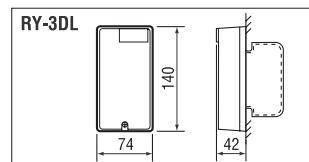

Wiring

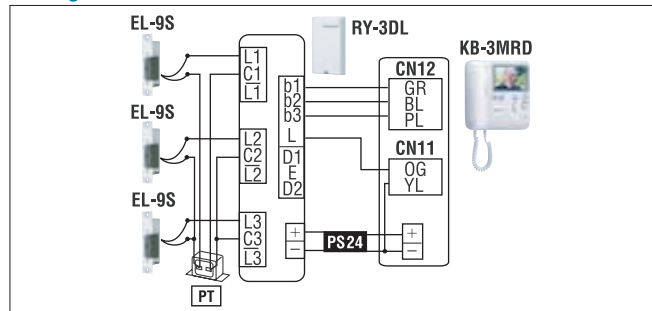

GR : Green. BL : Blue. PL : Purple. OG : Orange. YL : Yellow.

[PT] : AC transformer [PS24] : PS-2420DIN

Specifications

Power source	12~24V DC, 30mA. 12~16V AC, 60mA.
Power supply	PS-2420DIN, PS-1820DIN, PS-1215DIN, AC trans.
Relay contacts	Normally open output. 1A at 50V AC. 1A at 30V DC (for other types, use matching relay)
Wiring distance	Master to RY-3DL 50m(0.65mmø) 100m(1.0mmø) RY-3DL to EL-9S 50m(0.65mmø) 100m(1.0mmø)

30° angle box



Features

- 30° Angle Box for mounting video door station to position door camera to view visitors better.
- Designed for 1-gang surface mounting.

Used for

KC-DAR, KB-DAR, MK-DH

Unit dimensions

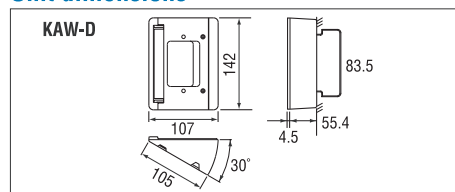
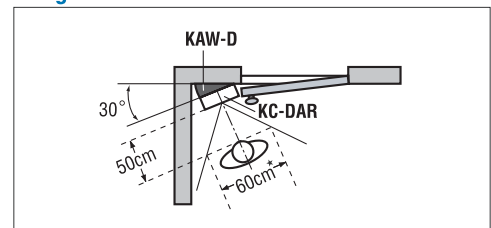

Image view area



*Figure is approximate.

Desk-top stand



Used for

MK-1GD, MK-1HD
MK-2MCD, MK-2HCD
KC, KB monitors