









# Chime Tone Intercom

## DOOR 2 ROOM 3 IE-2A2D(U)

Door station	Master station	Sub station	Lineup	
 <b>IE-JA</b> Door station → P.33	 <b>IE-2A2D(U)</b> Master station, 2 door releases	 <b>IE-2AD(U)</b> Master station	 <b>IEH-1C2D</b> Sub master station  <b>IEH-1C2D</b> 2 door release	 <b>EL-9S</b> Electric door strike → P.97
 <b>IF-DA</b> Door station → P.33			 <b>IER-2</b> Call extension → P.97	
<b>Power supply</b> 12~24V DC power supply ( PS-1215DIN→ P.100) 12~16V AC transformer ( 40781→ P.100)			 <b>TAR-3</b> External signaling relay → P.98	

### Features

- 3-station chime tone intercom
- 2 door stations w/door release
- All call type room calling
- Chime tone cutout at sub station
- Door selective monitoring at master station
- AC or DC power source

### Communication network

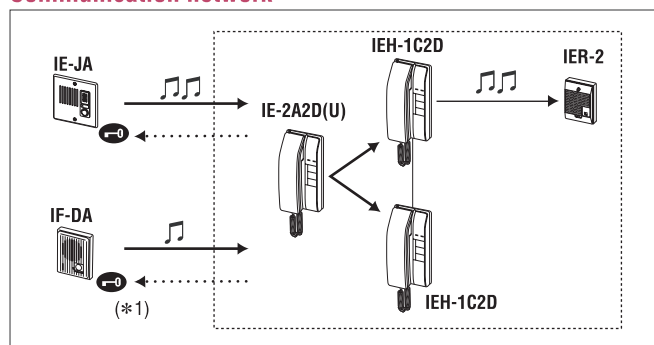

All call type voice calling between rooms  
 (\*) Available in IE-2A2D(U) or IE-2AD(U) w/RY-3DL

### Unit dimensions

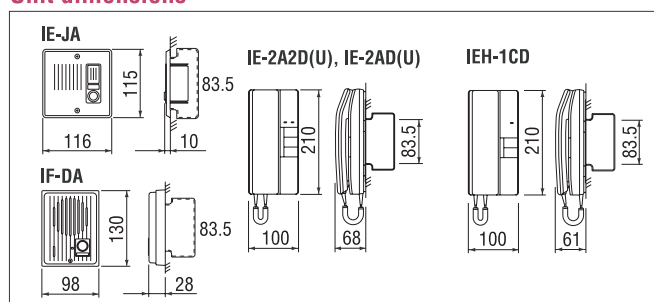

### Wiring

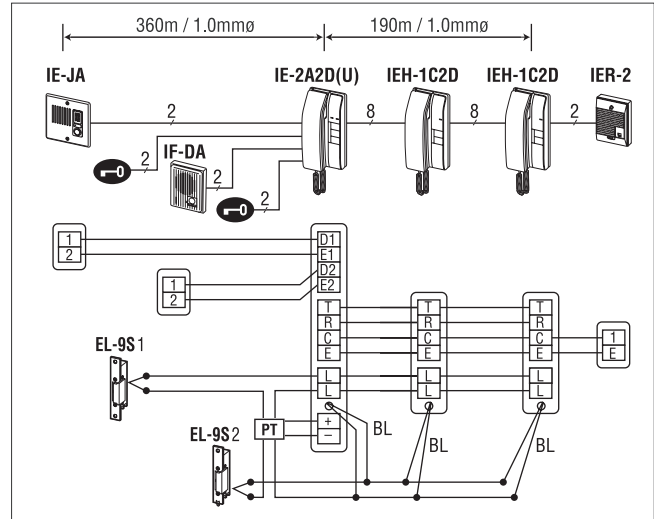

BL : Blue(2) PT : AC transformer

### Specifications (IE-2A2D(U))

Power source	12~16V AC, 200mA. 12~24V DC, 200mA.
Power supply	AC transformer 12~16V AC, 550mA (for both IE & EL-9S). PS-1215DIN 40781
Communication	Door calls in w/4- or 2-tone chime to all stations, 45 sec. Chime can be cut out at sub. Pick up any station handset to reply. Press CALL to call other stations with pretone & voice.
Door release	Contact rating: 24V AC/DC, 500mA
Wiring	2 parallel wires, non-polarized. 6 wires in loop, rooms.
Distance	IE-2A2D(U) to door 150m(0.65mmø) 360m(1.0mmø) Between rooms 75m(0.65mmø) 190m(1.0mmø)