







Chime Tone Intercom

DOOR 1 ROOM 1 IE-1AD(U)

Door station	Master station	Lineup
 <p>IF-DA Door station</p>	 <p>IE-1AD(U) Master station</p>	<div style="display: flex; justify-content: space-around;"> <div>  <p>AC-10S Access control keypad, surface mount</p> </div> <div>  <p>IER-2 Call extension</p> </div> </div> <div style="display: flex; justify-content: space-around;"> <div>  <p>AC-10F Access control keypad, flush mount</p> </div> <div>  <p>TAR-3 External signaling relay</p> </div> </div> <div>  <p>TAR-4 External signaling relay w/timer</p> </div>
<p>Power supply 12~24V DC power supply PS-12 12~16V AC transformer 40781</p>		

Features

- Chime tone intercom for 2 locations
- Door release button
- AC or DC power source

Communication network

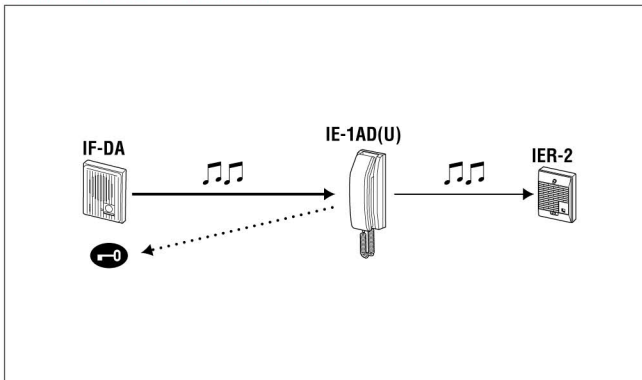

Unit dimensions

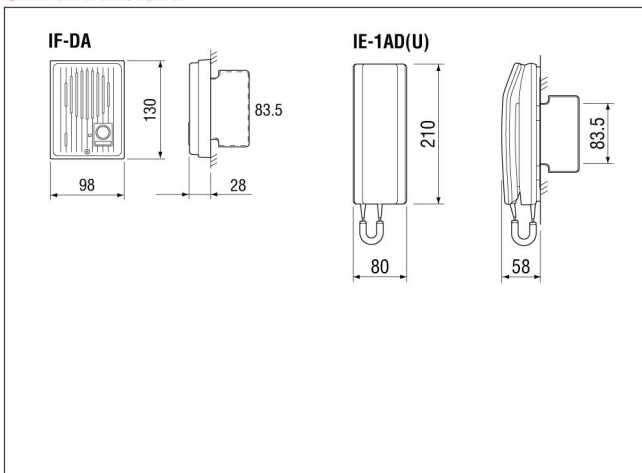

Wiring

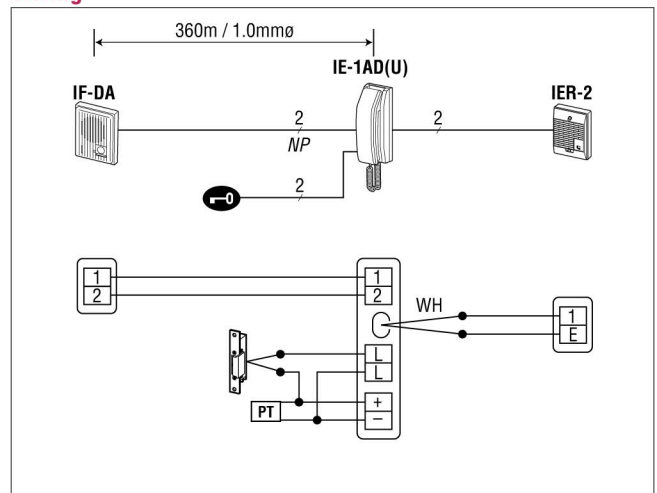

• Run audio wires in a separate jacketed cable from door release wires.

[PT] : AC transformer WH : White(2)

Specifications (IE-1AD(U))

Power source	12~16V AC, 180mA 12~24V DC, 160mA
Power supply	AC transformer PS-12, 40781
Communication	Door calls in w/4-tone chime, adjustable. Pick up handset to reply.
Door release	Contact rating: 24V AC/DC, 500mA
Wiring	2 parallel wires, non-polarized (+2 for Electric door strike)
Distance	IE-1AD(U) to door 150m(0.65mmø) 360m(1.0mmø)